

Web Interface for Ethernet to M-Bus LITE converters

Version: 1.2 EN

29. 11. 2019



Juraj Čaplický - Elektronika

Contents

Web Interface	1
Login	1
Configuration	2
Current Status	3
Ethernet configuration.....	4
Converter mode.....	5
M-Bus settings	5
Connection settings	5
Connection mode	6
TCP Client.....	6
TCP Server.....	6
UDP Single	7
UDP Multi	7
HTTPD Client.....	7
Extended Func	7
Misc. Config	8
Reboot	9
Logout.....	9

Web Interface

The web interface in the Ethernet to M-Bus LITE converters provides less features and displays settings in a slightly different layout than the web interface in the SMART converters.

To open the Web Interface type the IP address of the converter into the address bar of a web browser. The IP address of the converter depends on the configuration. A static IP address 192.168.0.7 is configured as default. A different factory preset may be provided when ordered.

The Web Interface works on all web browsers such as Mozilla Firefox, Google Chrome, Internet Explorer, Opera or Safari.

Login

A login dialog will be shown before the web interface can be accessed. The style of the dialog depends on the web browser. Enter the *User Name* (1) and *Password* (2) and click on the *OK* or *Log In* button (3).

The default log in credentials are:

user name: admin

password: admin

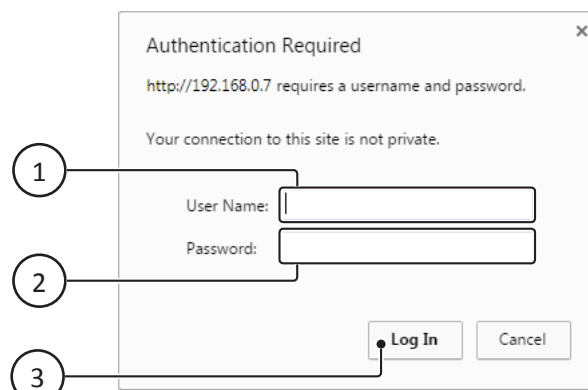

Login dialog.

Configuration

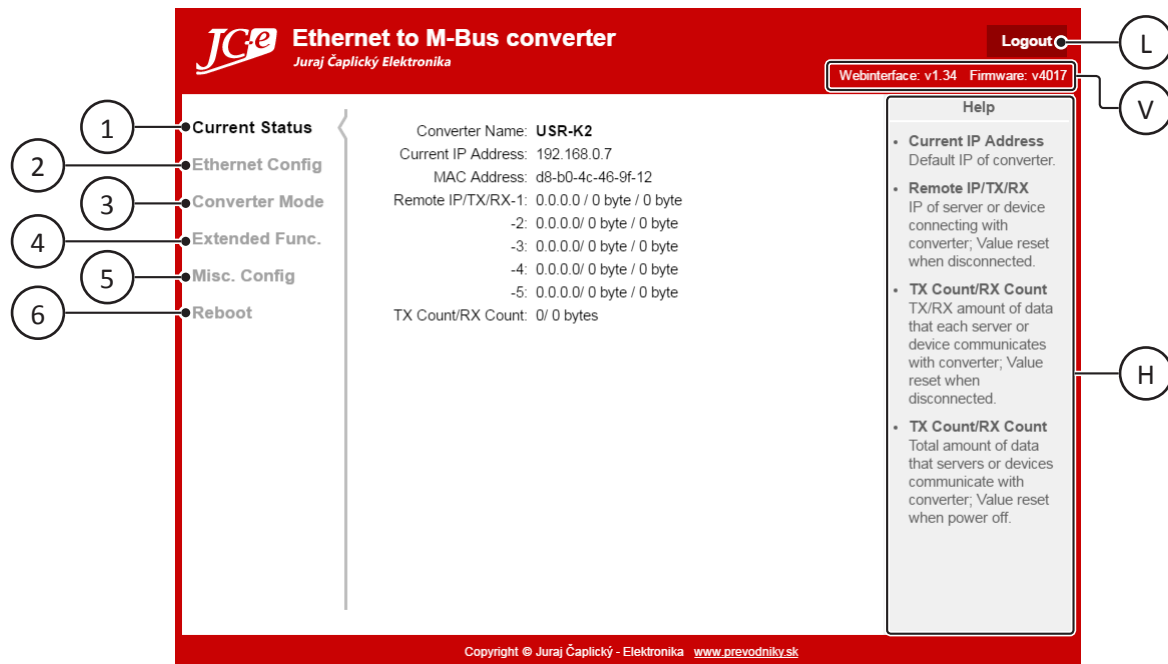

Initial screen.

1 - Current Status

Summary information about the current converter status.

2 - Ethernet Config

IP configuration, IP address, subnet mask etc.

3 - Converter Mode

Converter communication mode settings and M-Bus line communication settings.

4 - Extended Func.

Heartbeat packet settings, special TCP communication settings.

5 - Misc. Config

Converter name, Username and password, Webserver Port

Max amount of clients connected to TCP server, Reset when no data on TCP port timeout.

6 - Reboot

Converter restart.

L - Logout button

Logout from the configuration. Leads to the [Logout screen](#).

V - Version information area

Shows web interface and firmware versions used in the converter.

H - Help side panel

Contains short help for various features shown on the current web interface screen.

Current Status

Summary information about the current converter status.

The following information is listed:

- Converter name. This can be set on the *Misc. Config* screen under Converter name.
 - Current IP Address of the converter.
 - MAC address of the converter.
 - Remote IP/TX/RX-1 IP address of the remote connection #1 / amount of transmitted bytes / received bytes
 - -2 IP address of the remote connection #2 / amount of transmitted bytes / received bytes
 - -3 IP address of the remote connection #3 / amount of transmitted bytes / received bytes
 - -4 IP address of the remote connection #4 / amount of transmitted bytes / received bytes
 - -5 IP address of the remote connection #5 / amount of transmitted bytes / received bytes
- Note:** If the IP address is shown as 0.0.0.0 there is no Ethernet connection.
- TX Count/RX Count A sum of data transmitted / received to all the remote connections together.

The screenshot displays the web interface for an Ethernet to M-Bus converter. The page title is "Ethernet to M-Bus converter" with the logo "JCE" and "Juraj Čaplický Elektronika". The version information is "Webinterface: v1.34" and "Firmware: v4017". A "Logout" button is visible in the top right corner.

The main content area is divided into a left sidebar with navigation options and a main display area. The sidebar options are: Current Status (selected), Ethernet Config, Converter Mode, Extended Func., Misc. Config, and Reboot. The main display area shows the following information:

- Converter Name: **USR-K2**
- Current IP Address: 192.168.0.7
- MAC Address: d8-b0-4c-46-9f-12
- Remote IP/TX/RX-1: 0.0.0.0 / 0 byte / 0 byte
- 2: 0.0.0.0 / 0 byte / 0 byte
- 3: 0.0.0.0 / 0 byte / 0 byte
- 4: 0.0.0.0 / 0 byte / 0 byte
- 5: 0.0.0.0 / 0 byte / 0 byte
- TX Count/RX Count: 0 / 0 bytes

A "Help" section is located on the right side of the main display area, containing the following items:

- **Current IP Address**
Default IP of converter.
- **Remote IP/TX/RX**
IP of server or device connecting with converter; Value reset when disconnected.
- **TX Count/RX Count**
TX/RX amount of data that each server or device communicates with converter; Value reset when disconnected.
- **TX Count/RX Count**
Total amount of data that servers or devices communicate with converter; Value reset when power off.

The footer of the page contains the copyright notice: "Copyright © Juraj Čaplický - Elektronika www.prevodniky.sk".

Ethernet configuration

1 - IP type

Choose one of the options:

- Static IP - Static IP address.
The settings bellow will be used: Static IP (1), Submask (2), Gateway (3), DNS Server (4).
- DHCP - Dynamic IP address obtained by DHCP.
The settings below will be disabled and will not be used.

2 - Static IP

Static IP address of the converter. Default is 192.168.0.7.

Enter four numbers in a 0 - 255 range.

3 - Submask

A subnet mask that defines the number of bits taken from the IP address that are assigned for the host part.

Enter four numbers in a 0 - 255 range.

4 - Gateway

The gateway address or router that allows communication with other LAN segments. The gateway address should be the IP address of the router connected to the same LAN segment as the converter. The gateway address must be within the local network address range. Enter four numbers in a 0 - 255 range.

5 - DNS server

Domain Name Server allows the name of a remote device to be resolved automatically. If the device is DHCP enabled, the DHCP server provides the DNS server IP address. This address will be used first. If the DNS resolve fails, user defined DNS server IP address will be used. Enter four numbers in a 0 - 255 range.

S - Save button

Saves the new settings in the converter. After this the converter should be restarted from the *Reboot screen*.

C - Cancel button

Reloads current settings from the converter. No changes to the configuration will be made.

Converter mode

Converter's mode of operation.

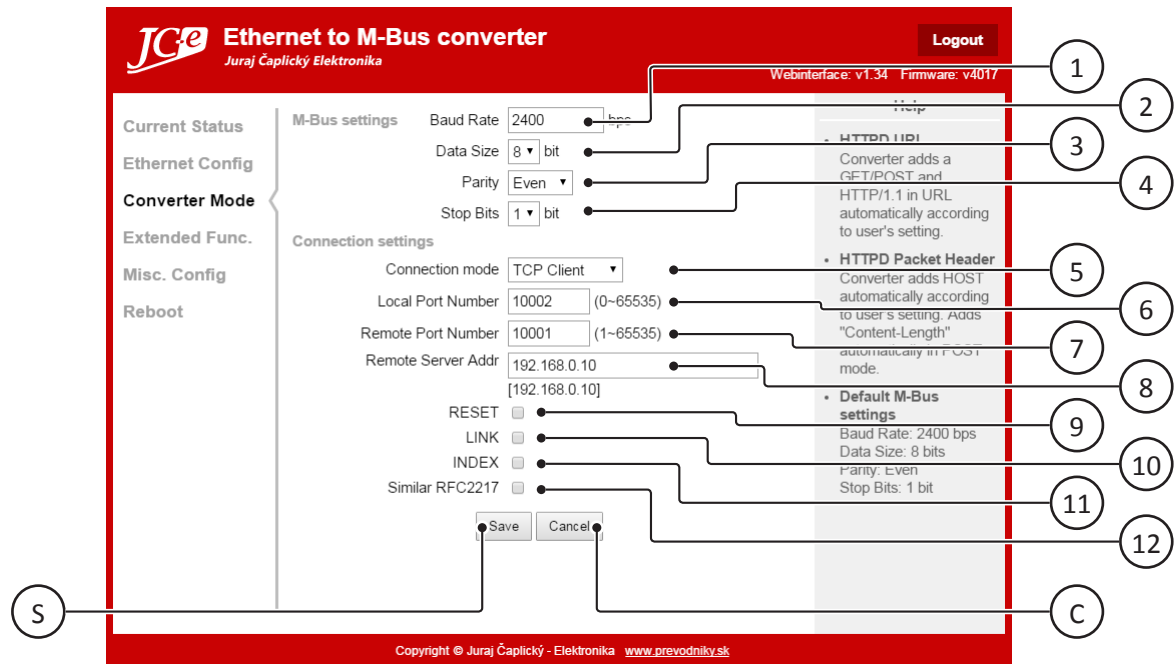

M-Bus settings

Communication settings for the M-Bus line.

1 - Baud Rate

Baud rate of the M-Bus line. Default is 2400 bps.

Allowed speeds: 300, 600, 1200, 2400, 4800, 9600 bps.

2 - Data Size

M-Bus communication data size in bits. Default is 8 data bits.

3 - Parity

Parity for the M-Bus data communication. Default is even parity.

4 - Stop Bits

Choose amount of stop bits for the M-Bus data communication. Default is 1 stop bit.

Connection settings

Converter network communication mode and settings.

5 - Connection Mode

Choose one of the following modes:

- TCP Client
- TCP Server
- UDP Single
- UDP Multi
- HTTPD Client

For more details see the [Connection mode](#) chapter.

6 - Local Port Number

Port of the converter. Enter a number in a 1 - 65535 range.

7 - Remote Port Number

Remote server port. Enter a number in a 0 - 65535 range.

8 - Remote Server Addr.

Remote server address. Current value is also shown below the input box.

Enter four numbers in a 0 - 255 range separated by dots without a dot at the end.

9 - RESET

Used in TCP Client mode. The converter will try to connect to the TCP Server 30 times, if it is unable to establish a connection it will automatically restart itself. Used only in special cases.

Turned off by default.

10 - LINK

Setting for an internal hardware pin to indicate that a communication connection is established. Not used in the converter.

Turned off by default.

11 - INDEX

Used in the TCP Server mode. When multiple connections are established, each client connection will be marked with an index number internally by the converter. The converter adds a custom header with this index information to the beginning of each incoming and outgoing serial port data stream.

This setting is not recommended for standard M-Bus protocol communication.

Turned off by default.

12 - RFC2217

RFC2217 is a communication standard that allows to setup a COM port remotely. Communication settings will then be synchronised between the virtual COM port and M-Bus port of the converter.

This will automatically set all the M-Bus communication settings: Baud Rate, Data Size, Parity, Stop Bits.

To create a virtual COM port the USR-VCOM application can be used. It can be downloaded here:

<https://www.usriot.com/support/downloads/usr-vcom-virtual-serial-software.html>

If it is turned on, this functionality also needs to be enabled in the virtual COM port software.

Turned off by default.

S - Save button

Saves the new settings in the converter. After this the converter should be restarted from the *Reboot screen*.

C - Cancel button

Reloads current settings from the converter. No changes to the configuration will be made.

Connection mode

The converter works as a simple Ethernet to serial converter in all modes.

TCP Client

TCP packets are used to transport serial data through Ethernet in this mode.

The converter connects from its *Local Port Number* to the *Remote Server Address* at the *Remote Port Number*.

TCP Server

TCP packets are used to transport serial data through Ethernet in this mode.

The converter awaits client connections on its IP address on the Local Port Number.

The amount of clients that can connect to the server is limited by the *Max Clients Connect To TCP Server* setting available on the *Misc. Config* screen.

A maximum of 4 TCP/IP client connections at the same time is supported.

Data from the M-Bus line is sent to all established TCP/IP client connections.

UDP Single

UDP packets are used to transport serial data through Ethernet in this mode.

The converter listens on its *Local Port Number* and send all data only to the *Remote Server Address* on the *Remote Port Number*.

UDP Multi

UDP packets are used to transport serial data through Ethernet in this mode.

The converter listens on its *Local Port Number* and send data to any remote client that requests M-Bus data.

Each client that sends a data request gets its own M-Bus port response.

HTTPD Client

In this mode the converter acts as client for a HTTP Daemon.

Extended Func

Extended converter functions.

The screenshot displays the web interface for an Ethernet to M-Bus converter. The page title is "Ethernet to M-Bus converter" with the logo "JCE" and "Juraj Čaplický Elektronika". The version information is "Webinterface: v1.34" and "Firmware: v4017". A "Logout" button is in the top right corner.

The interface is divided into several sections:

- Current Status**
- Ethernet Config**
- Converter Mode**
- Extended Func.** (This section is expanded to show configuration options):
 - Heartbeat Packet Type: None (dropdown), ASCII (dropdown)
 - Register Packet Type: None (dropdown)
 - Impersistent connection:
 - TCP Server-kick off old connection:
 - Buffer Data Before Connected:
- Misc. Config**
- Reboot**

At the bottom of the configuration area are "Save" and "Cancel" buttons.

On the right side, there is a "Help" section with the following content:

- Custom Heartbeat Packet**
Function not available, doesn't support more than 40 bytes length.
- Custom Register Packet**
Function not available, doesn't support more than 40 bytes length.
- TCP Server-kick off old connection**
Used in TCP Server mode, when enabled opening a new connection kicks off the old connection.
- Buffer Data Before Connected**
When enabled, the data sent by serial port is cached before the TCP connection is established.

At the bottom of the page, the copyright notice reads: "Copyright © Juraj Čaplický - Elektronika www.prevodniky.sk"

Misc. Config

1 - Converter name

Enter converter name.

2 - Webserver Port

Port number of the web interface. Default value is 80. Enter a number in a 1 - 65535 range.

3 - Username

Username used to login to the web interface. Enter ASCII characters only.

4 - Password

Password used to login to the web interface. Enter ASCII characters only.

5 - Max Clients Connect To TCP Server

Maximum amount of clients connections allowed when the converter is in TCP Server mode. Enter a number in a 1 - 4 range.

6 - Reset Timeout

When the network port is without data a restart of the converter will be performed after this timeout. Number represents seconds. If the value is set to 0 the functionality is disabled. Default value is 0. Enter a number in 60 - 65535 range.

S - Save button

Saves the new settings in the converter. After this the converter should be restarted from the [Reboot screen](#).

C - Cancel button

Reloads current settings from the converter. No changes to the configuration will be made.

Reboot

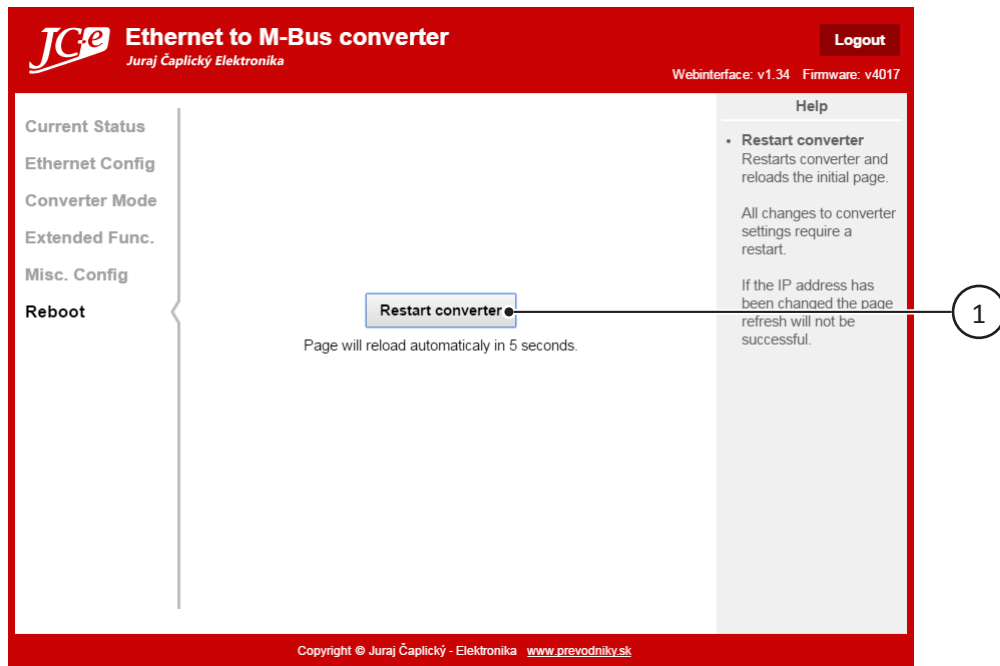

1 - Restart button

Restarts the converter. The web interface will auto refresh itself after a 5 second time-out.

Note: If the converter's IP address setting has been changed you will need to open the Web Interface at the new address.

Logout

Pressing the Logout button in the web interface will bring up the Logout screen. In order to complete the logout the web browser session must be closed. This can be done only by completely closing the web browser. The logout is actually not necessary as the web interface session automatically expires after a certain time period of inactivity, when no pages from the web interface are opened.

